

We understand your challenges in Waste Water Treatment plants



- > Robust and compact design
- > Proven two pin cardan joint
- > Lower maintenance cost

Roto Pumps in Waste Water Industry

Roto Pumps has a vintage of over 45 years in providing fluid handling solutions to spectrum of industries. These pumps can handle wide variety of fluids ranging from clean and clear liquids to abrasive, corrosive, viscous and solid laden media. In Waste Water Industry these pumps are used in all major stages including primary and secondary clarification process, sludge thickening process, digestion process, de-watering and sludge incineration. Some of the design features include:

- Flow proportionate to speed - Can be used for dosing and metering applications
- Self Priming - Excellent suction lift capability and can operate under vacuum
- Non-Clogging - Can handle solids in suspension
- Low internal velocity - Can handle sheer sensitive media
- Positive Displacement - Flow independent of Head
- Will not vapor lock - Can handle air, liquid and combination together

RJ series pump for precise metering applications

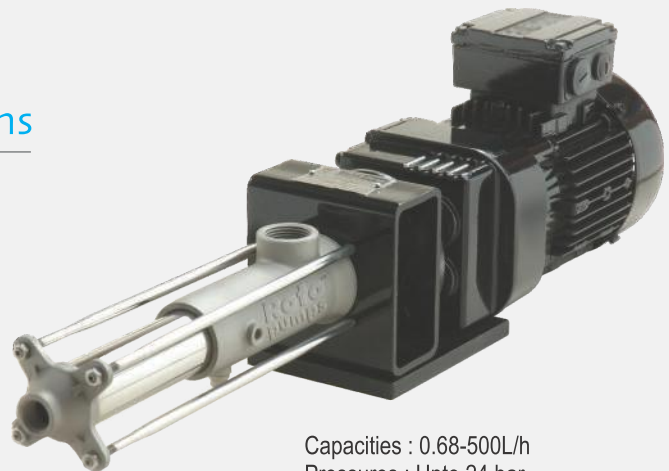

Capacities : 0.68-500L/h
Pressures : Upto 24 bar

RJ series of dosing pumps

Roto RJ series pumps are developed for low flow applications that demand high accuracies and repeatability. These pumps can handle wide variety of fluids ranging from clean and clear liquids to abrasive, corrosive, viscous and solid laden media.

Advantages

- High dosing accuracies - fluctuation $\pm 1\%$.
- Smooth and non - pulsating flow - no need of pulsation dampners.
- Low sheer and linear flow - can handle sheer sensitive media.
- Single rotating element - no valves or gears required.

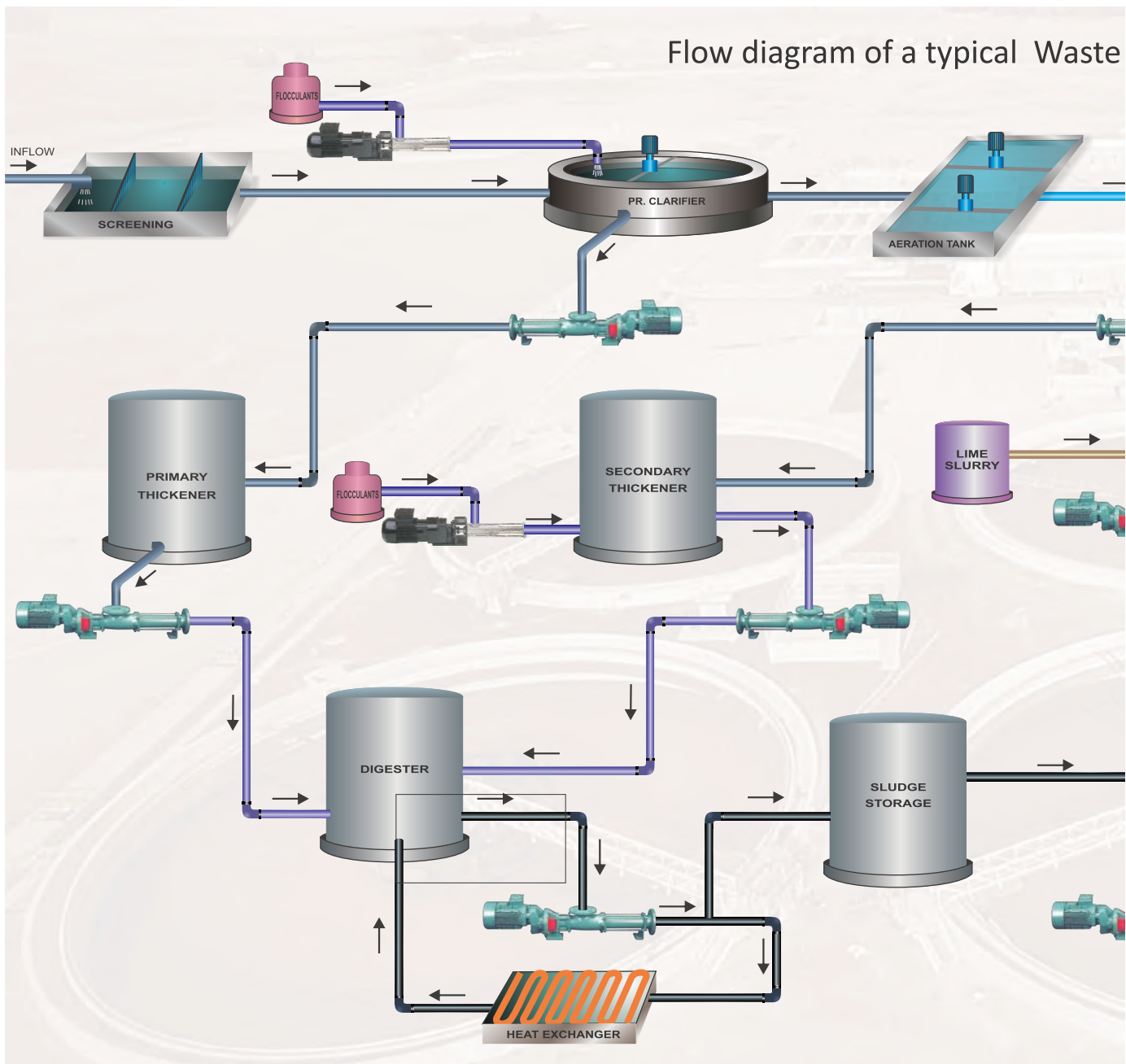

FLUIDS HANDLED

- | Sludge Making | | |
|------------------------------|--------------------|---------------------|
| • Primary Sludge | • Thickened Sludge | • Stabilized Sludge |
| • Secondary Sludge | • Digested Sludge | • Bio Sludge |
| • Secondary Activated Sludge | • Flotation Sludge | • Settled sludge |
| • Secondary Excess Sludge | • Returned Sludge | • Undigested Sludge |

Roto @ work in Waste Water Industry



Water Treatment plant

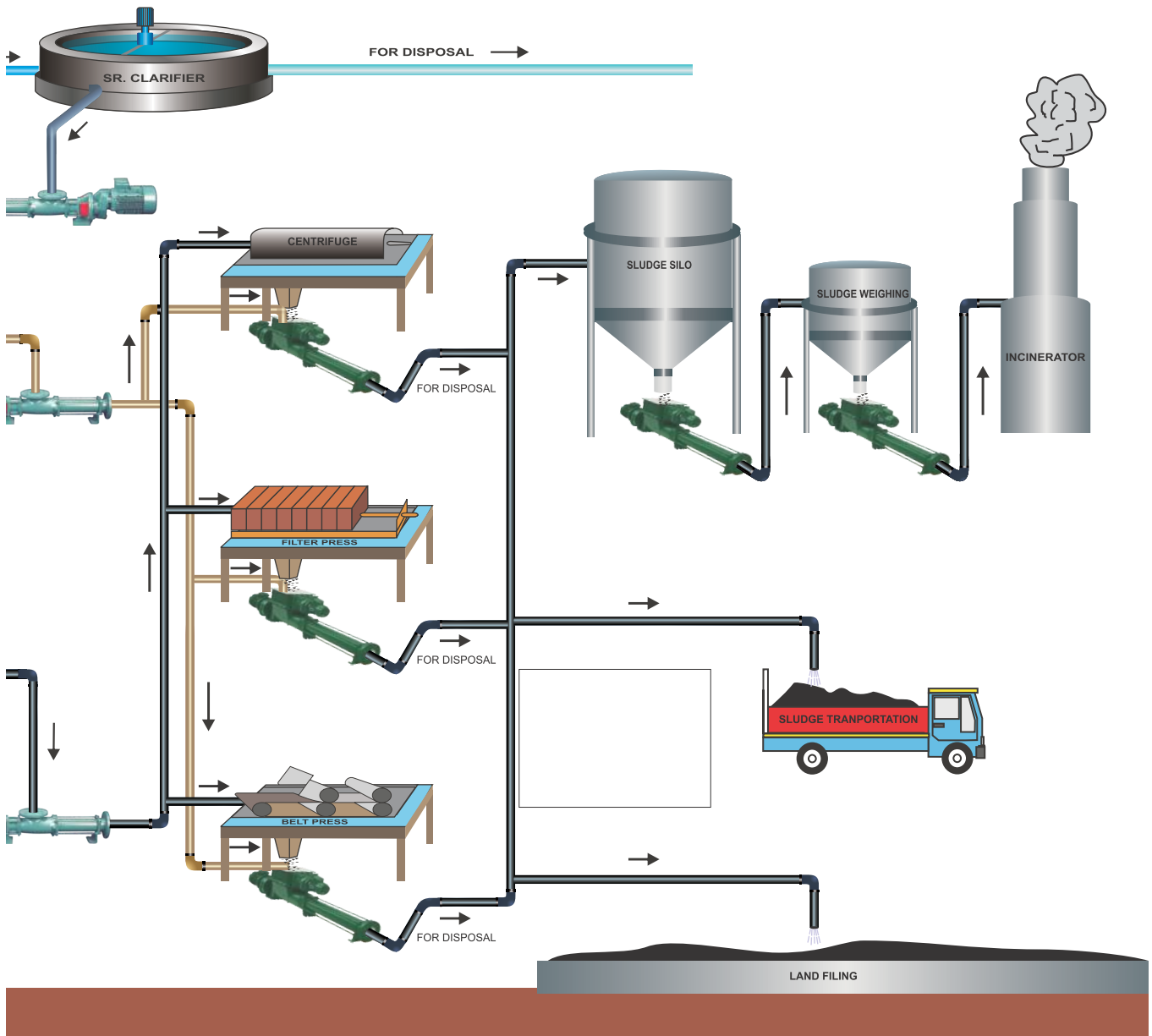

Dosing

- Milk of Lime
- Concentrated Flocculent
- Polymer Solution
- Metallic Salts
- Polyelectrolyte
- Polyaluminum Chloride Solution
- Polyacrylamide Flocculent
- Alum Flocculent

Dewatering

- Dewatered Sludge
- Sludge Cake



Extended Pitch Geometry

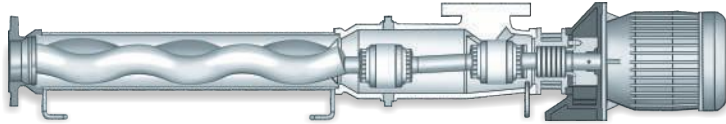

Capacities 420 M³/hr

Pressures 6 Bar

Submerged Vertical



Capacities 420 M³/hr
Pressures 12 Bar

Standard Pitch Geometry

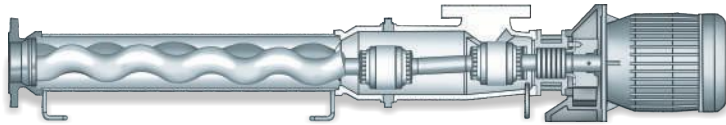

Capacities 250 M³/hr

Pressures 48 Bar

Wide Throat Medium Consistency

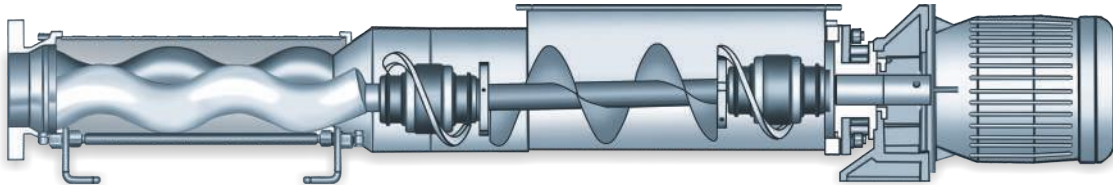

Capacities 150 M³/hr

Pressures 36 Bar

Wide Throat High Consistency

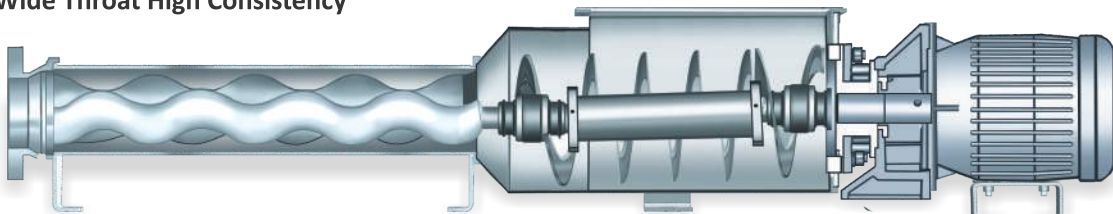

Capacities 100 M³/hr

Pressures 36 Bar

Wide Throat High Consistency with Bridge Breaker

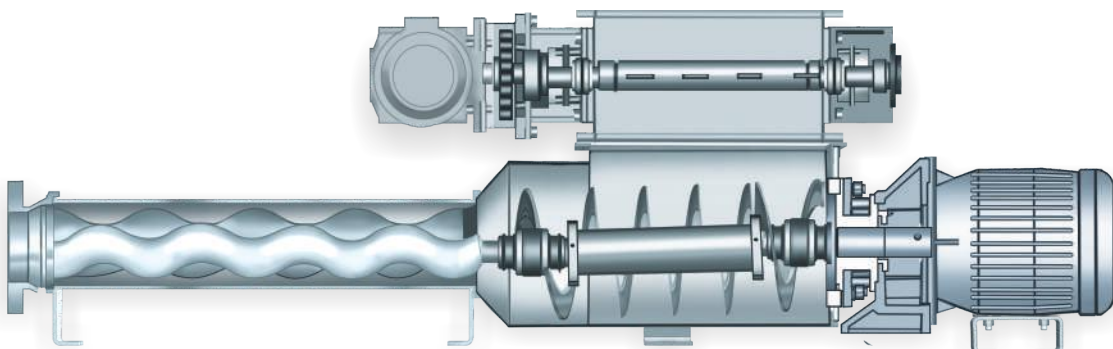

Capacities 100 M³/hr

Pressures 36 Bar

Roto Pumps Limited, Manufacturing Plant, India



Melbourne Office & Warehouse



Manchester Office & Warehouse



Roto Pumps North America, Inc



ROTO PUMPS LTD.

Marketing Head Office

Roto House,13, Noida Special Economic Zone, Noida - 201305, INDIA
Tel.: +91 120 2567902-5 Fax: +91 120 2567911
Email: contact@rotopumps.com

Branch Offices and Warehouses

United Kingdom

Unit 1 St Elizabeths Park, Grey Street, Denton, Manchester, M34 3RU
Tel.: +44 161 4775511 Fax: +44 161 4747900
Email: sales@rotopumps.co.uk

Australia

26, Deans Court, Dandenong South, Victoria 3175
Tel.: +61 3 97945200 Fax: +61 3 97945900
E mail: melb@rotopumps.com.au

www.rotopumps.com

Subsidiaries

Roto Pumpen GmbH

Am Brühl 17, 32423 Minden, Germany
Tel: +49 571 40410077,
Email: sales@rotopumpen.de

Roto Pumps North America, Inc.

5889 S Garnett Rd. Tulsa ,Oklahoma 74146
Tel: +1 918 280 9144,Fax: +1 918 806 6853
Email: info@rotopumpsna.com

Roto Pumps Africa (Pvt) Ltd

3, Sun Rock Close Germiston 1401, Africa
Tel.: +27 10 100 3774
Email: sales@rotopumps.co.za